

SF100 Balcony Energy Storage System

Usage Guidelines



CONTENTS

1. Product Introduction.....	2
2. Product Functions Introduction	2
3. Product Technical Parameters	3
4. Product Packing List.....	4
5. Product Instructions	5
6. Product Installation.....	7
6.1 Preparation Before Installation	7
6.2 Installation Stpes	7
7. APP Introduction.....	9
8. Safety Guidelines	12
9. Disposal	13
10. Troubleshooting	14
10.1 Solar Panel not Charging.....	14
10.2 Product not Discharging.....	14
11. After-Sales Service.....	14



Attention

- 1. Please read the product user manual carefully before using.**
- 2. Do not handle the product violently, impact it, or puncture it.**
- 3. Please recycle and dispose this product according to local laws and regulations.**
- 4. Do not disassemble the product by yourself. If you have to disassemble this product, you must obtain authorization from the manufacturer.**
- 5. During installation, please pay attention to the positive and negative polarity of the cables to avoid incorrect connections or short circuits.**
- 6. If you need to replace the cables or add additional expansion batteries during daily use, please turn off the product and disconnect the power supply. Otherwise, it may cause a spark and cause fire.**
- 7. Before shipping this product, we have careful inspections and packaging. If you receive a damaged package or missing parts, please contact the dealer for assistance. We are delight to help.**

1. Product Introduction

This product is a balcony energy storage system, mainly used for solar panels and microinverter home grid-connected system. This product with a built-in PV HUB and LiFePO4 battery, it can improve the utilization rate of home grid-connected system and meet the demand for solar energy storage. The energy storage battery supplies power to the microinverter when during peak hours or at night. It save electricity costs for families and help the application of clean energy.

The product is matched with an independent APP, which can allocate energy storage and output according to the household electricity consumption time and power, support real-time viewing of the working status and historical data of the balcony energy storage system.

2. Product Functions Introduction

- ① PV- input port
- ② PV+ input port
- ③ Waterproof vent valve
- ④ Ground wire
- ⑤ Battery display
- ⑥ ON/OFF Button
- ⑦ Battery Output Port P+
- ⑧ Battery Output Port P-
- ⑨ Communication Antenna

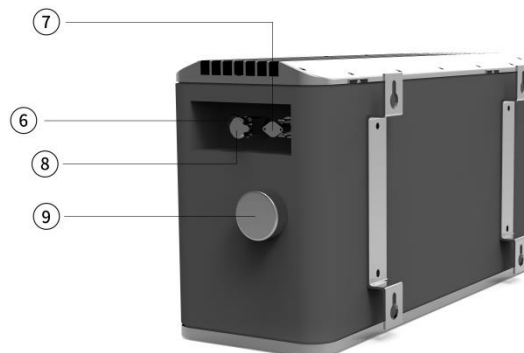



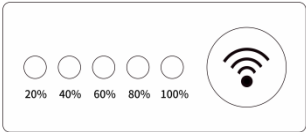







3. Product Technical Parameters

	Item	Specification
Appearance	Model	SF100
	Weight	21Kg±0.2Kg
	Size	490mm*170mm*265mm
Battery System	Battery Type	LiFePO4 Battery
	Battery Lifecycle	6000+times
	Rated Battery Voltage	51.2V
	Battery Operating Voltage Range	43.2V-58.4V
	Battery Capacity	1382Wh
	Battery Percentage Prompt	
	PV Input Voltage	12V-60V
	PV MPPT Voltage Range	26V-60V
	Input Current/Power (PV-BAT)	1ports≤30A/800W*1 (800W Max)
	Output Voltage (PV-Microinverter)	12V-60V
	Output Voltage (BAT-Microinverter)	48V
	Output Current/Power	≤30A/200-1200W
	APP	Support
Wireless	Bluetooth 5.2 WIFI 2.4G	

	BMS	OVP,UVP,OCP,SCP,OTP,UPT,etc
	IP Grade	IP65
	Charge Temperature Range	-20-55℃
	Discharge Temperature Range	-30-60℃
	Relative Humidity	60±25%
	Storage Temperature	5-30℃
	Altitude Range	≤2000m

4. Product Packing List

Serial number	Item	Quantity	Picture
1	Host SF100	1	
2	Installation Brackets	2	
3	Short Screw	4	
4	M4 Flange Nut	1	
5	Screw Mounting Rubber Plug	4	

6	Long Screw	4	
7	PV+ Extension Cable	1	
8	PV- Extension Cable	1	
9	P+ Parallel Connection Cable	1	
10	P- Parallel Connection Cable	1	
11	Usage Guidelines	1	

5. Product Instructions

(1) This product supports PV input voltage of 12V-60V, the best MPPT voltage is 26V-60V, it is recommended to use solar panel power of 800W.

(2) The maximum output power of this product is 1200W to match with the microinverter, it is recommended to use 600W/800W microinverter.

(3) According to user needs, the company can provide solar panels and microinverters.

(4) The working mode of the product can be set through the APP. You can choose the power storage priority mode, the power use priority mode, the PV direct output mode, and the three modes can be switched (for APP, please see article 7). It can also be set through the POWER button of this product. The POWER button can be clicked three times continuously within 3S, and the above three modes can be switched cycle to meet the various needs of users.

(5) You can judge whether the mode is successfully switched from the blinking state of the power indicator: **When the product is in the open state, press the power switch continuously and quickly 3 times, you can switch the working mode of the product, and the corresponding LED light flashes 6 times when the working mode is successfully switched.**

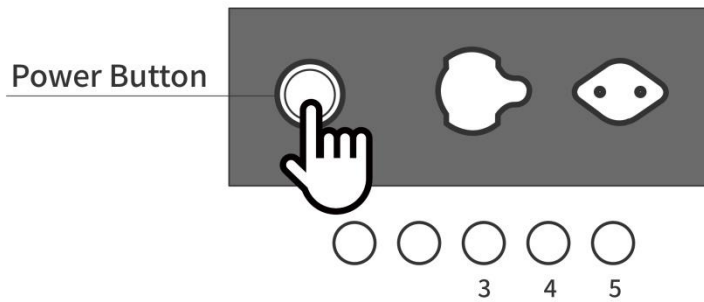

- The fifth LED flash six times from left to right represents the power storage priority mode.
- From left to right, the fourth LED flashes six times, indicating the power use priority mode.
- From left to right, the third LED flash 6 generation PV direct output mode.

(8) Click the main button 5 times or more within 3S, you can reset the WIFI and restore the factory Settings.

(9) The working diagram of the product is as follows.

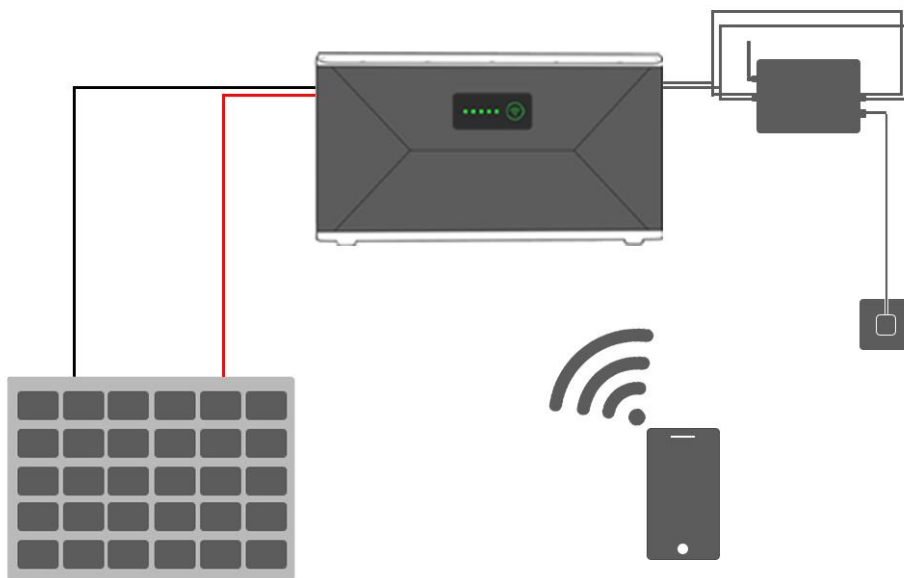

SF100 Working Principle Diagram

6. Product Installation

(1) Preparation Before Installation:



Phillips Screwdriver



Electric Drill



Gloves

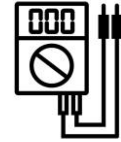

Multimeter



Safety Goggles



Measuring Tape



Insulated Shoes



Hammer

Tools: Phillips screwdriver; Electric drill, Gloves, Multimeter, Safety goggles, Measuring tape, Insulated shoes.

(2) Installation Steps

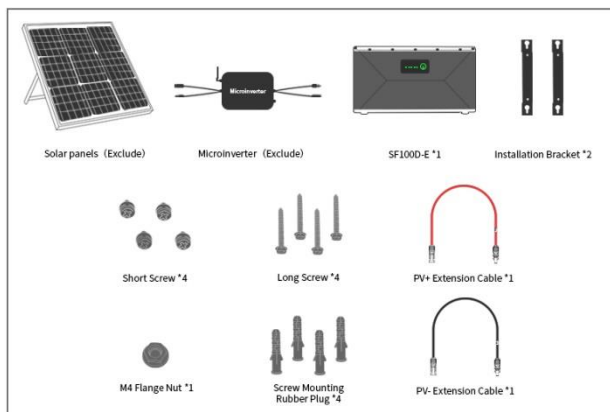

Step 1 : Sort all the accessories of the product.

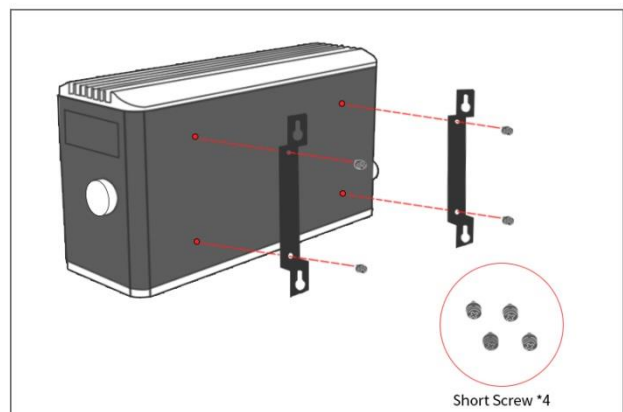

Step 2 : Use 4 short screws to secure the 2 mounting brackets to the back of the product and ensure that the screws are securely installed.

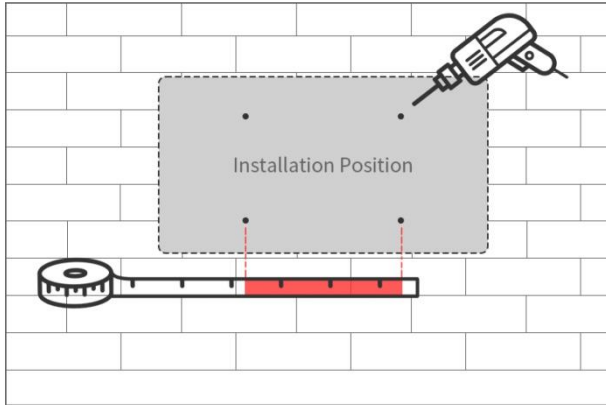

Step 3 : According to the distance of the bracket hanging hole on the back of the product, choose a wall that can withstand gravity, and mark the wall with a ruler.

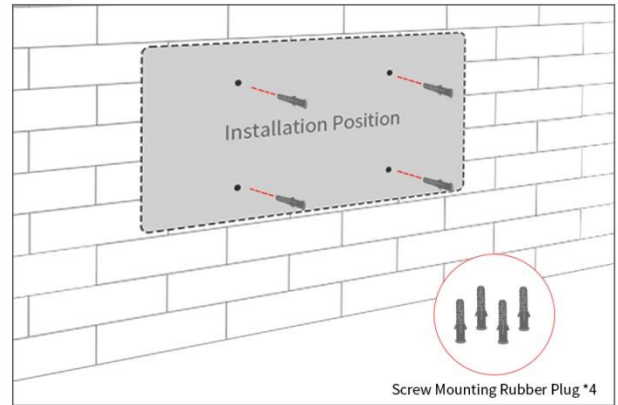

Step 4: Use an electric drill to drill holes and insert screw plugs into the wall, Knock the screw plugs flat with a hammer to the wall.

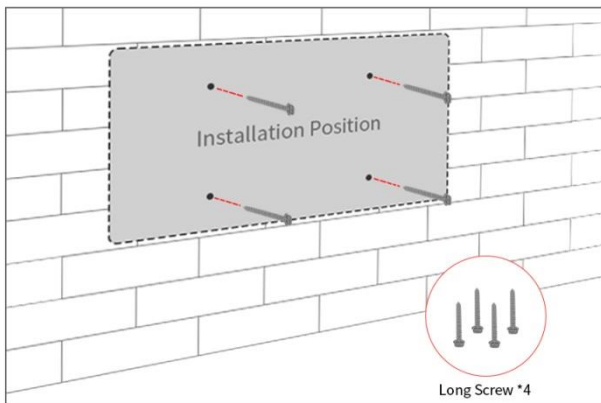

Step 5 : then screw the long screws into the screw mounting holes, The distance between the screw caps and the wall must be 8mm.

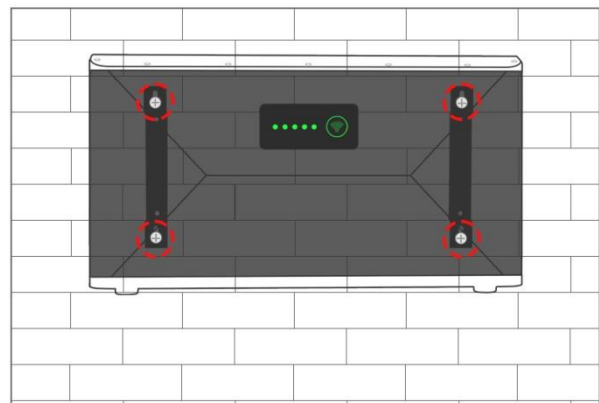

Step 6 : Align the mounting bracket hanging hole on the back of the product with the screw on the wall, hang the product on the wall, and ensure that the installation is firm.

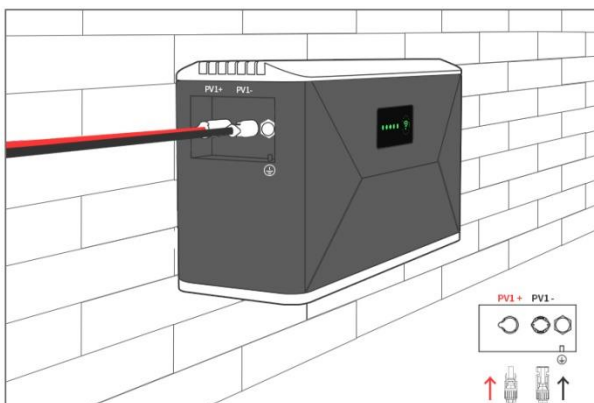

Step 7 : Connect the PV input cable

Connect the positive wire of the solar panel to PV+ and the negative cable to PV-

 Attention	<p>Please pay attention to distinguish the positive and negative electrodes of the solar panel to avoid connection errors that will cause this product to not work or even damage.</p>
---	--

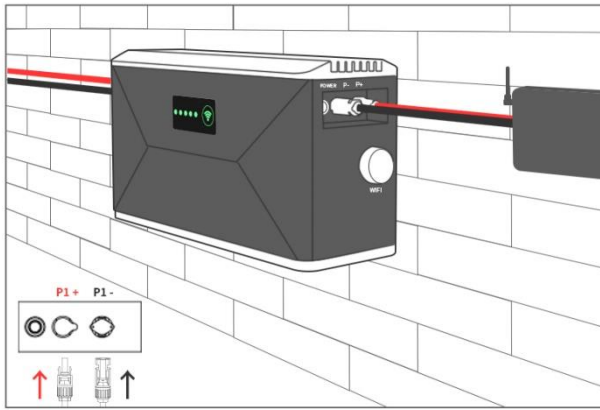

Step 8 : Connect the microinverter cable

- A. Connect the " P+" port to the positive cable of the microinverter.
- B. Connect the " P-" port to the negative cable of the microinverter.

 Attention	<p>A. If one 600W or 800W microinverter is used, connect the P+ and P- output ports of the balcony energy storage to one microinverter. If two 600W and below microinverters are used, the balcony energy storage P+ and P- output ports need to be connected in parallel with parallel cables, and then connected to the microinverter.</p> <p>B. When connecting the microinverter, please distinguish the P+ and P- output ports to avoid damage to the product or the microinverter caused by connection errors.</p>
---	--

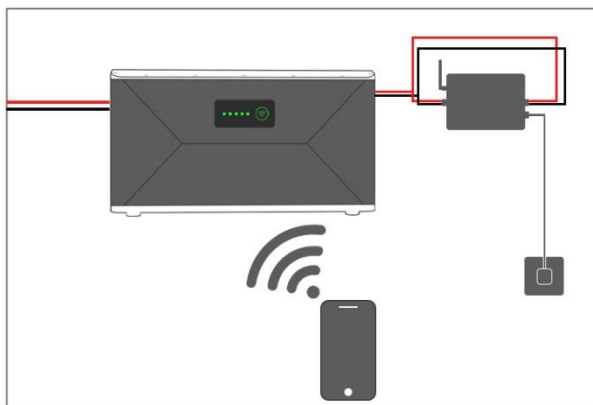

Step 9 : Set up this product through the APP

Turn on the power switch of the product, download the APP to debug and control the product (See article 7 for specific operations).

7. APP Introduction

(1) After the product is installed, you can download the APP to connect to the product for operation (specific installation steps are as follows).

Step 1: Scan the QR code to download the APP.



Step 2: Register and log in to the APP (A) .

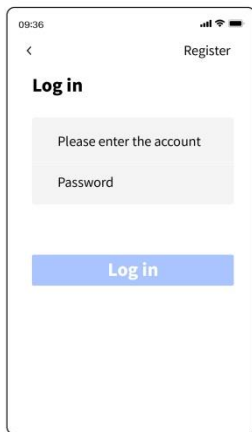

(A)

Step 3: Turn on the portable power switch  of the balcony energy storage, and the WIFI indicator flashes into the distribution network state  .

Step 4: Turn on Bluetooth  and WIFI  , and the WIFI network is 2.4G frequency.

Step 5: Open the APP (B) . If "Connect Device" pops up, click Add (C) .If "Connect Device" doesn't pop up, click "+" to select add device and click Connect (D) .

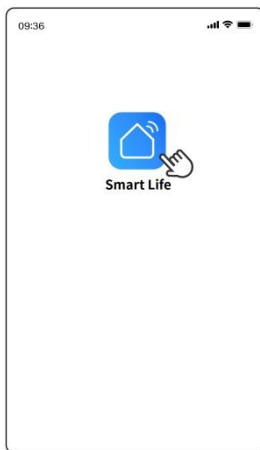

(B)



(C)

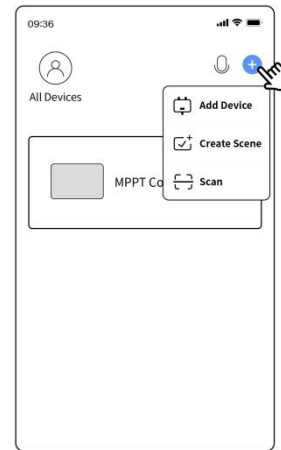

(D)

Step 6: Select the corresponding WIFI name and enter the password to enter the add device wait (E) (F)

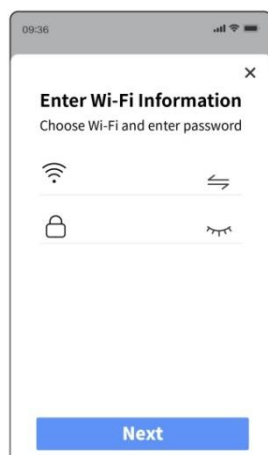

(E)



(F)

Note: If the connection is not possible, please check whether the WIFI network is 2.4G frequency, non-2.4G frequency will not be connected successfully.

Step 7: When the device is added (G) and the WIFI icon on the product is steady on, click Finish to enter the APP operation interface (H) .

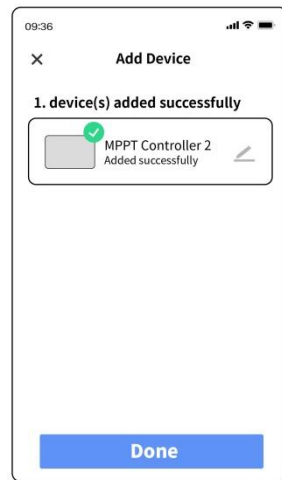

(G)

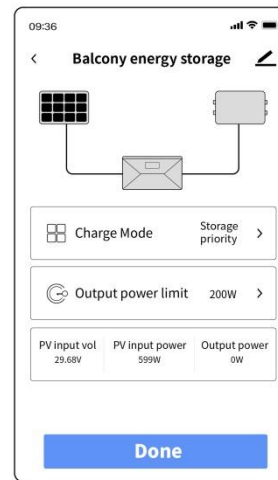

(H)

(2) The APP supports the setting of working mode. The user can choose the working mode of the product in the APP according to the power consumption situation. The user can choose the power storage priority mode, the power use priority mode, the PV direct output mode, the power storage and the power use mode to meet the various power needs of the user.

- Power storage priority mode

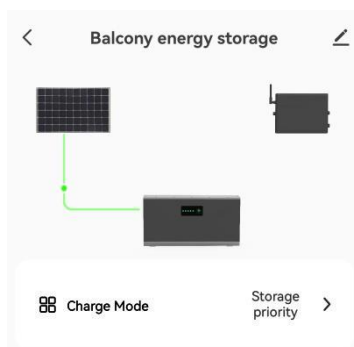

When the solar panel generates electricity, the internal battery of this product is charged.

- **Power use priority mode**

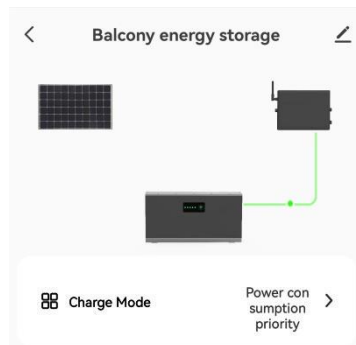

When the solar panel power generation capacity is insufficient or there is no solar cell power generation, the built-in battery output of this product provides power to the microinverter.

- **PV direct output mode**

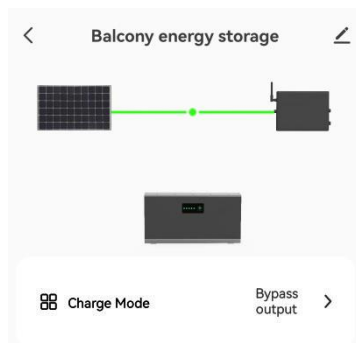

When the solar panel generates electricity, it supplies power directly to the microinverter.

(3) After the first installation of the product, the user needs to set the output power and time of the product in combination with the household electricity consumption, which can better save the electricity cost for the family.

(4) It can remotely control and view the working status and historical charge and discharge data of the product.

(5) Before the product leaves the factory, the default working mode is the power storage priority mode.

8. Safety Guidelines

(1) Do not place this product near any heat sources, such as open flames or heating furnaces.

- (2) Do not place this product into position nearby any liquid, and do not drop this product into water.
- (3) It is prohibited to use this product in areas with strong static electricity or strong magnetic fields.
- (4) Do not dismantle the product or puncture it with any sharp objects.
- (5) Do not short-circuit the product using wires or other metallic objects.
- (6) Please use solar panels and microinverters manufactured by reputable companies to prevent damage to the product.
- (7) When using this product, strictly adhere to the recommended operating temperature range stated in the user manual. High temperatures may cause the battery to catch fire or explode.
- (8) Do not stack any heavy objects on top of this product.
- (9) Avoid impact, dropping, or severe vibration. If significant external force is applied, immediately disconnect the power and cease using the product.
- (10) In case of a fire, please use the following recommended extinguishing materials in the given order: water or water mist, sand, fire blanket, dry powder, carbon dioxide fire extinguisher.
- (11) Install this product in a location where children and pets cannot access it.

9. Disposal

This product contains a lithium iron phosphate battery, and should be professionally disassembled and disposed of according to local laws and

regulations, with materials sorted accordingly.

10. Troubleshooting

(1) Solar panel not charging

- A. Check that the solar panel's working range matches this product;
- B. Check that the solar panel cable is securely connected and that the positive and negative terminals are correct;
- C. Check that the solar panel is exposed to sunlight. If the solar panel is not exposed to sunlight, it may not work.

(2) Product not discharging

- A. Check whether the product's battery has power. If it doesn't, charge the product first;
- B. Check if the product switch is turned on;
- C. Check if the cable connecting the product and microinverter is connected securely and the polarity is correct;
- D. Check if the microinverter is functioning properly;
- E. Check if the grid has power. When the grid is down, the microinverter will not operate.

11. After-sales service

When a fault occurs during the use of the product, please follow the "troubleshooting" method in Article 10 and still cannot eliminate the fault, please contact the dealer in time to give clear feedback to the after-sales personnel: product model, purchase date, contact phone number, fault

phenomenon.

(1) The product warranty period is five years.

The warranty period starts from the date of purchase by the consumer. To determine the purchase date, please keep related receipts or online purchase records.

(2) Within the warranty period, if any damage is caused by product design, materials, or non-human factors, the company will assume the obligation of free maintenance and replacement of parts.

(3) The following situations are not covered by the warranty:

- A. Unauthorized repairs or modifications;
- B. Product performance failure caused by human factors;
- C. Damage caused by natural disasters, lightning, accidents, or other irresistible factors;
- D. Damage to the appearance of the product caused by use, which is not covered by the warranty.

(4) Warranty record

Date of purchase:

Product SN:

Maintenance date	Fault cause	Maintenance result	Maintenance person

--	--	--	--

CE FC RoHS 

Made in China